

NB3300 ADSL Modem Router

BUILD OR EXTEND A SWITCHED NETWORK AND CONNECT IT TO ADSL BROADBAND INTERNET

- Integrated ADSL modem
- Works with all major Australian ISPs
- Up to 8Mbps download
- NAT firewall protects against intruders
- 4-port 10/100 switch for building or expanding your network
- Router to share your ADSL Internet connection with up to 253 users
- Works with all ADSL service providers
- Built-in DHCP server
- Supports VPN, IPSec & PPTP pass-thru
- Remote Administration via the Internet
- Easy to install: compatible with PC, Mac, Linux and any TCP/IP system



Quick Start Guide

Contents

Default Settings & Facts	3
Resetting	3
Power	3
NetComm ADSL Modem Router Quick Start	4
One page setup for most ADSL services	4
Introduction	6
Chapter 1: Getting to know your NetComm ADSL Modem Router	8
1-1 What is xDSL	8
1-2 Contents of the NetComm ADSL Modem Router Package	8
1-3 Features of the NetComm ADSL Modem Router	8
Chapter 2: Hardware Installation & Setup	10
2-1 Rear Panel & Connections	10
2-2 Front Panel LEDs	11
2-3 What is a Micro filter for?	12
2-3 System Requirements and Setup	13
Chapter 3: Internet Access	18
3-1 Prepare your network information	18
3-2 Web-based User Interface	19
3-3 Initial Configuration – Setup	20
Chapter 4: Advanced Applications	25
4-1 DHCP Configuration	25
4-2 Access Control	25
4-3 Port Forwarding Settings	28
4-4 Special Application	29
4-5 Dynamic Routing	30
4-6 Static Routing	31
4-7 Administration Settings	32
4-8 Status Monitor	33
4-9 DMZ Host	34
4-10 Log	34
4-11 VPN Passthrough	35
Chapter 5: Macintosh Setup	36
5-1 Hardware Connections	36
5-2 Computer Network Configuration	36
5-3 NetComm ADSL Modem Router Configuration	37
5-4 Adding NetComm ADSL Modem Router to an Existing Network	37
Chapter 6: Trouble Shooting	38
Hardware	38
Client Side (Computers)	39
Appendix A: Frequently Asked Questions	40
Appendix B: Technical Specifications	42
Appendix C: Glossary	43
Appendix D: Registering your NetComm Product	46
Contact Information	46
Product Warranty	46
Limitations of Warranty	47

Default Settings & Facts

The following lists the default settings of your NetComm ADSL Modem Router.

Note: It is highly recommended that you enable security settings in the router before connecting your router to your network.

Router

LAN IP:	192.168.1.1
Username:	<none>
Password:	admin
WAN port:	ADSL only (built in ADSL modem)

Resetting

While using or installing your NetComm ADSL Modem Router you may need to utilise the reset feature. There are two types of reset:

Soft

A soft reset will restart the unit and reconnect to the internet using the settings stored previously, none of your settings are deleted. To perform a soft reset briefly press the reset button on the back of the unit.

Hard

A hard reset will return your unit to its factory default setting, meaning that you will lose all configurations and logs set/stored previously. To perform a hard reset press and hold in the reset button on the back of the unit for 10 seconds.

Power

Ensure that you only use the Power Adaptor supplied (5V DC, 3amps, Center pole positive) with your NetComm ADSL Modem Router.

NetComm ADSL Modem Router Quick Start

The following Quick Start pages are intended to be used by an advanced user to quickly configure the NetComm ADSL Modem Router. It assumes that you are familiar with *TCP/IP Networking*. If you need further explanation please refer to the more detailed sections of this document. This guide also presumes that your NetComm ADSL Modem Router is set to factory defaults (See *Resetting* on previous page if required).

One page setup for most ADSL services.

1. Connect your computer to one of the four LAN ports on the NetComm ADSL Modem Router and ensure you have a link. Connect your ADSL modem (supplied by your ISP) to the WAN port of the NetComm ADSL Modem Router.
2. Set the Network Card of your computer to use DHCP or assign it an IP address in the range of 192.168.1.2 ~ 254.
3. Open a web browser (ensuring that it is set to access the Internet via the LAN not by a dial-up networking account). Browse to the NetComm ADSL Modem Router's default IP (192.168.1.1). The main menu of the router should open displaying the **“One Page Setup”**.

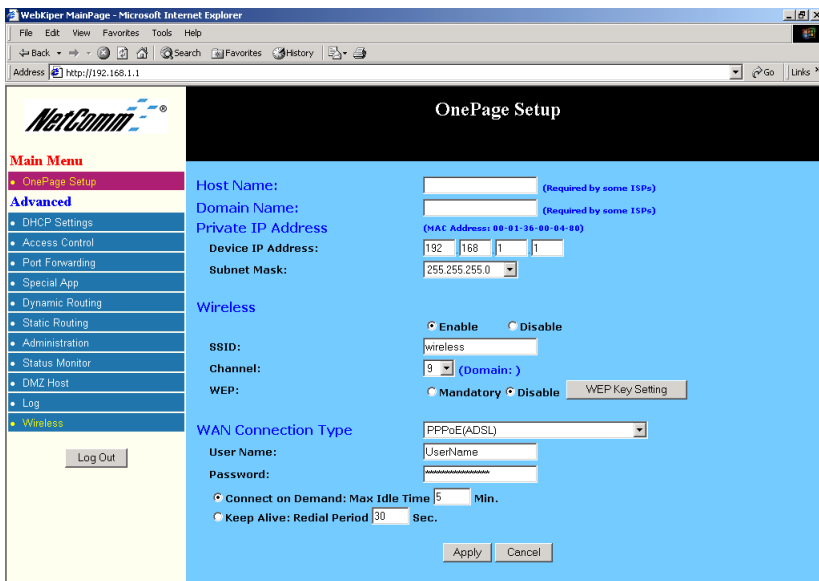

Note: *You may be prompted for a log-in, there is no User Name and the Password is “admin”.*

4. Change your **“WAN Connection Type”** to **“PPPoE (ADSL)”**.
5. Set your **“User Name”** and **“Password”** as provided by your ISP.
6. If you wish to make services available to external Internet users, even when you are not using Internet services from inside your network, you can choose **“Keep Alive”**. Alternatively for extra security you can choose **“Connect on Demand”**.

7. Click “**Apply**”. Your NetComm ADSL Modem Router will attempt to use your settings to connect to your ISP. You can check the results on the “**Status Monitor**” page.
8. If you have a DHCP server already active on your network it is recommended that you disable either the NetComm ADSL Modem Router's built in DHCP server or the existing DHCP server. Please note that *Microsoft Internet Connection Sharing* is a DHCP server.

Introduction

Congratulations on your purchase of the NetComm ADSL Modem Router. The ADSL Modem Router is the perfect solution for connecting a small group of computers to a high-speed Broadband Internet connection or to a remote LAN via an ADSL line. The ADSL Modem Router supports a maximum downstream data transmission rate of 8Mbps and an upstream rate of 640Kbps. Configured as a DHCP server, the ADSL Switch Router assigns an IP Address to every connected computer and acts as the only externally recognized Internet device on your Local Area Network (LAN). With built-in NAT, the ADSL Modem Router serves as an Internet firewall, protecting your network from access by outside users and can also be configured to block internal users' access to the Internet.

Unlike other routers, which often only share 10Mbps over all of their connections, the NetComm ADSL Modem Router is equipped with a 4-port 10M/100Mbps auto-sensing switch, dedicating a possible 100Mbps to each and every ethernet connected computer. Not only will all of your computers be able to enjoy lightning-fast Broadband Internet connections, but they will also be able to share internal network data at high speed.

With a web-based UI (User Interface), this NetComm ADSL Modem Router is easy to setup and maintain via web browsers such as Netscape Communicator and Internet Explorer.

About this Guide

This guide contains information about installing and configuring your NetComm ADSL Modem Router. It is designed to guide users through the correct setup procedures for both hardware installation and basic configuration. Later, it shows how to complete advanced configuration to get the best operating performance from the NetComm ADSL Modem Router.

Chapter 1: Get to know your NetComm ADSL Modem Router

This chapter describes the package contents and provides a list of features of the NetComm ADSL Modem Router.

Chapter 2: Hardware Installation & Setup

This chapter describes the steps for hardware installation of the NetComm ADSL Modem Router.

Chapter 3: Internet Access

This chapter describes the steps for basic configuration and start up of the NetComm ADSL Modem Router.

Chapter 4: Advanced Applications

This chapter describes how to configure advanced functions in order to get the most from your NetComm ADSL Modem Router.

Chapter 5: Macintosh Setup

This Chapter provides instructions on how to set up Macintosh computers in your network.

Chapter 6: Trouble Shooting

This chapter describes potential problems you may run into and the suggested remedies.

Conventions

The following explains the conventions used throughout this document.

<i>Italics</i>	New words, terms, or special emphasis. E.g. <i>Getting to know your NetComm ADSL Modem Router.</i>
“Boldface”	Buttons, checkboxes, or items that you can select from screens, menus, or dialog boxes. E.g. Click “OK” to restart
<i>Boldface Italics</i>	Items in <i>Bold Italics</i> are samples only and you should enter other names, numbers, or words to substitute.

Chapter 1: Getting to know your NetComm ADSL Modem Router

This chapter describes the package contents and provides a list of features of the NetComm ADSL Modem Router.

1-1 What is xDSL

DSL (Digital Subscriber Line) refers to a technology used to increase the data capacity of standard twisted-pair wires that are generally used to connect most households to the phone network. In addition, this technology allows simultaneous voice and high-speed data transmission over a single pair of telephone wires.

There are seven kinds of DSL service, each with its own compromises between speed, distance, cost, and reliability. These services are either symmetrical (data flows at the same speed in both directions), or asymmetrical (the downstream capacity is higher than the upstream capacity).

What is ADSL?

Asymmetric Digital Subscriber Line (ADSL), as its name indicates, is an asymmetrical data transmission technology with higher traffic rates downstream and lower traffic rates upstream. It is suitable for Internet users because information is usually downloaded more often than uploaded, such as when surfing the web or downloading files.

1-2 Contents of the NetComm ADSL Modem Router Package

After carefully unpacking the shipping carton, check the contents listed below:

- NetComm ADSL Modem Router
- Power Adapter - 5VDC 3A Center Pole Positive
- This Manual

1-3 Features of the NetComm ADSL Modem Router

Your NetComm ADSL Modem Router contains the following features:

- Asymmetrical data rates of up to 8,000kbps downstream and 640kbps upstream.
- Supports ITU G.dmt, ITU G.lite, and ANSI T1.413 issue 2 standards.
- Integrates four 10/100BASE-T/TX auto-sensing switch ports.
- Uses NAT to allow all of your network's computers to connect to the Internet using only one public IP address.
- Supports PPPoE to connect to ISPs.
- Built-in web-based user interface for easy configuration and management through common web browsers like Netscape or Internet Explorer.
- Supports DHCP client to use either a dynamic IP Address or a fixed IP Address from your ISP.
- Built-in DHCP server to automatically assign and manage LAN IP addresses.

-
- Allows administrators to block specific LAN users from accessing specified applications or services.
 - Allows external Internet users to access information from an internal computer (Virtual Server or Port Forwarding).
 - Provides unrestricted two-way communication between one computer on your LAN and certain Internet services like conferencing, video and gaming applications.
 - Enhances routing performance by using Dynamic or Static routing.
 - Allows administrators to change WAN MAC address.
 - Compatible with all popular Internet applications.

Chapter 2: Hardware Installation & Setup

This chapter provides information about your NetComm ADSL Modem Router's physical features and gives step-by-step installation instructions.

2-1 Rear Panel & Connections

The following figure shows the rear view of the NetComm ADSL Modem Router and illustrates how the cables connect to the interfaces on the rear panel.



- Plug one end of the UTP cable into the WAN port, the other into the the other into the wall jack that is connected to the ADSL service.
- Connect a computer, with a Network Interface Card installed, to one of the four LAN Ports.
- Connect the external power supply to the NetComm ADSL Modem Router.
- Port 4 can cascade to another network device (usually a hub or switch). Make sure the slide switch is in "X" mode when connecting to an MDI-X port.
- The Reset button is used to reboot the device - press once quickly, or for clearing configuration settings back to factory default values - press for longer than 3 seconds.

2-2 Front Panel LEDs

The following figure shows the front view of the NetComm ADSL Modem Router.



The LEDs on the front panel indicate the status of the unit.

Power: Green On when power is on.

Diag: Red Lights up during system check when the power is initially connected. If the Router is working properly, the light should switch off after the diagnostic has been completed.

ADSL port

Link: Green Blinking when ADSL line is training.

On when ADSL line is ready.

Activity: Yellow Blinking when data is being received/transmitted through ADSL line.

LAN ports

Link/ACT: Yellow On when link is up and operating at 10Mbps.

Green On when link is up and operating at 100Mbps.

Yellow/ Green Blinking when data is being received/transmitted through the LAN port.

FD/COL: Green On when operating at full duplex mode (10/100M).

Blinking when a collision is occurring on the port.

2-3 What is a Micro filter for?

Micro filters are used to prevent common telephone equipment, such as phones, answering machines and fax machines, from interfering with your ADSL service. If your ADSL enabled phone line is being used with any other equipment other than your ADSL Router then you will need to use one micro filter for each phone device.

Splitters may be installed when your ADSL line is installed or when your current phone line is upgraded to ADSL. If your telephone line is already split you will not need to use a microfilter - check with your ADSL service provider if you are not sure.

Each micro filter is connected in-line with your telephone or fax machine so that all signals pass through it. Telephones and/or facsimiles in other rooms that are using the same extension will also require microfilters. The following diagram gives an example of connecting your ADSL Modem/Router using a Microfilter.

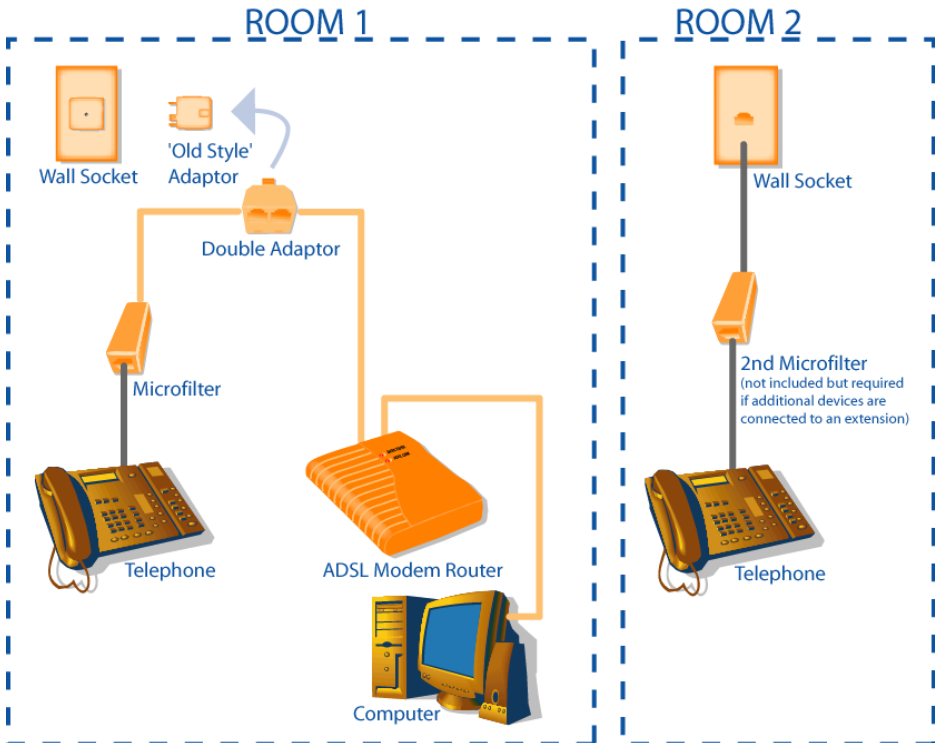

2-3 System Requirements and Setup

To connect to the Internet, an ADSL enabled phone line and an Internet access account from an ISP are required. In order to operate with the ADSL Modem Router, each computer that is to be connected to the ADSL Modem Router should have the following items installed:

1. Ethernet NIC (Network Interface Card: a 10Base-T or 10/100Base-T/TX Ethernet card).
2. Standard twisted-pair Ethernet cable (UTP network cable) with RJ-45 connectors.
3. System OS: Windows 95, Windows 98, Windows NT4.0, Windows 2000, Windows Me, Windows XP, or Macintosh
4. TCP/IP network protocol.
5. Web browser, such as Microsoft Internet Explorer or Netscape Navigator.

Installing the TCP/IP Protocol in Windows

If you are not sure whether the TCP/IP Protocol has been installed, follow these steps to check, and if necessary, install TCP/IP onto your computer.

1. Click the **“Start”** button. Choose **“Settings”**, then **“Control Panel”**.
Double-click the **“Network”** icon. Your Network window should appear.

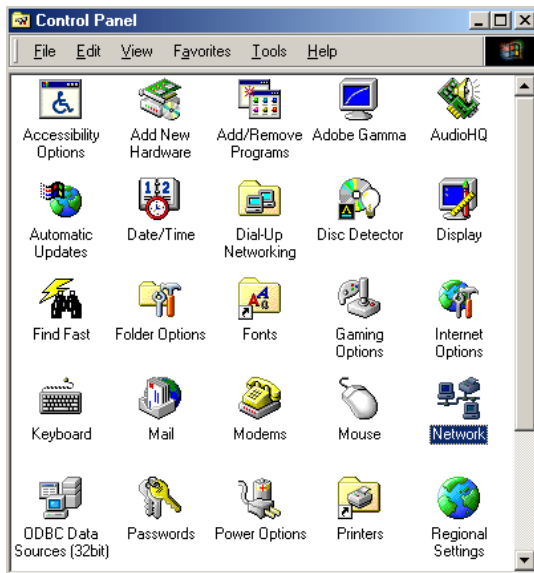

Select the **“Configuration”** tab.

Note: For Windows 2000 & Windows XP the settings can be reached by

Click the “Local Area Connection” icon on the right bottom side of your desktop screen.

In the “Local Area Connection Status” window, click “Properties” button then



your Network window will appear.

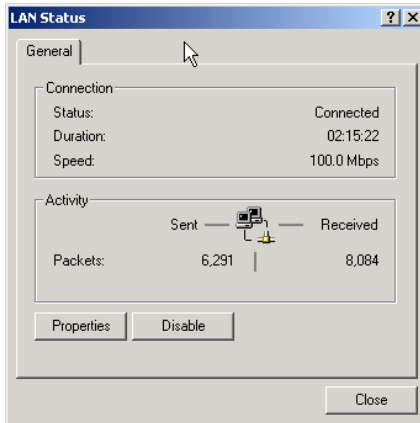

2. Check whether the TCP/IP Protocol has already been installed and bound to your Network Interface Card.

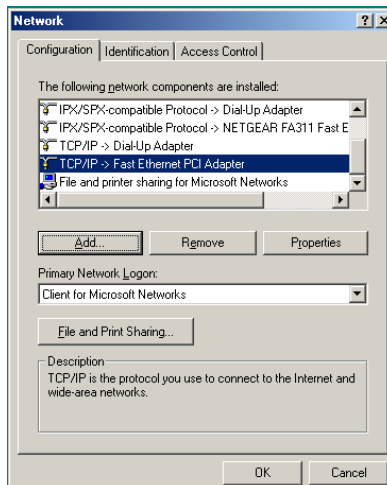

- If yes, go to step 7.
 - If no, click the “Add” button.
3. Double-click “**Protocol**” on the Select Network Component Type or highlight “**Protocol**” then click “**Add**”.

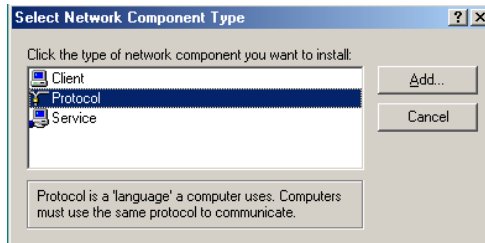

4. Highlight “**Microsoft**” under the list of manufacturers.

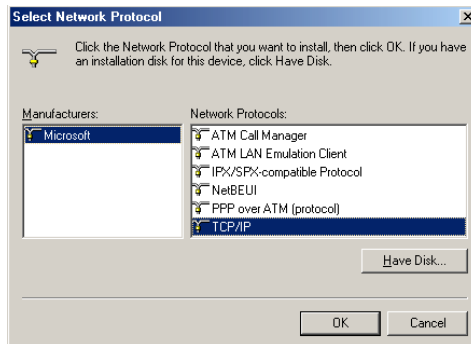

Double-click “**TCP/IP**” from the list on the right or highlight “**TCP/IP**” then click “**OK**” to install TCP/IP.

5. After a few seconds, you will be brought back to the Network window. The TCP/IP Protocol should now be on the list of installed network components (refer to point 2).
6. Click the “**Properties**” button.

The TCP/IP Properties window consists of several tabs. Choose the “**IP Address**” tab.

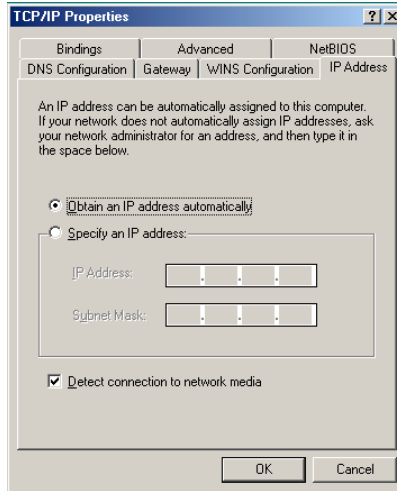

7. Select “**Obtain an IP address automatically**”. Click “**OK**”. Restart your computer to complete the TCP/IP installation.

Fixed IP Addresses Configuration

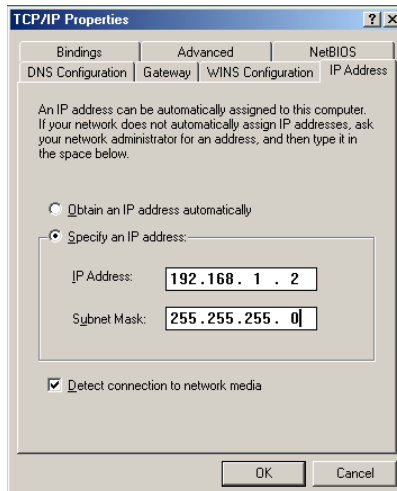

Fixed IP addresses may be assigned to network devices for many reasons, such as the server computers or printers which are consistently accessed by multiple users. To set up computers with fixed IP Addresses, go to the “**IP Address**” tab of the “**TCP/IP Properties**” window as shown above.

1. Select “Specify an IP address” and enter “192.168.1.***” in the “IP Address” location (where *** is a number between 2 and 254 used by the NetComm ADSL Modem Router to identify each computer), and the default “Subnet Mask” 255.255.255.0”.

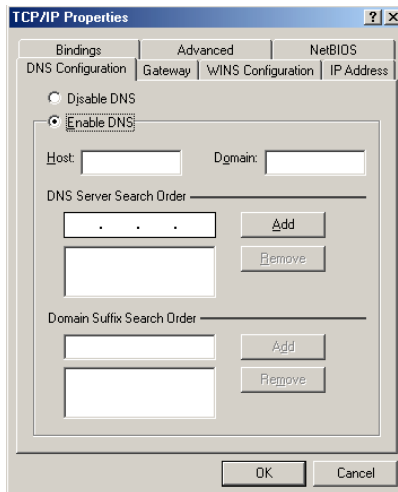

Note: *No two computers on the same LAN can have the same IP address but they should have the same Subnet Mask.*

2. Select “Enable DNS” in the “DNS Configuration” tab and enter the “DNS IP Address” obtained from your ISP in the “Server Search Order” location. Click “OK”.

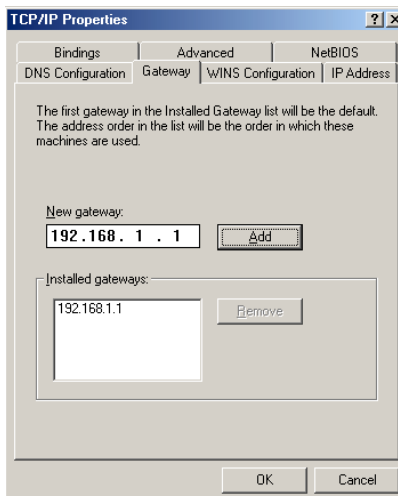

3. Click “Gateway” tab and enter the NetComm ADSL Modem Router’s default gateway value 192.168.1.1 in the “New gateway” field, then click “Add” Button. Click “OK”. Restart your computer to complete the TCP/IP installation.

Chapter 3: Internet Access

This chapter describes the procedures necessary to configure the basic functions and to start up your NetComm ADSL Modem Router. On successful completion of these procedures, you will be able to access the Internet via your NetComm ADSL Modem Router.

3-1 Prepare your network information

When setting up your NetComm ADSL Modem Router, in order to allow a quick reference point, it is suggested you complete the table below with the necessary information which should be supplied by your ISP:

Provided by some ISPs (✓ tick indicates common minimal requirements)

Host Name: _____

Domain Name: _____

WAN/Public IP address given by ISP: ✓

Dynamic

Static

IP Address: _____

Subnet Mask: _____

Default Gateway: _____

DNS Server Primary: ✓ _____

DNS Server Secondary: _____

DNS Server Third: _____

VPI and VCI values:

VPI: ✓ _____

VCI: ✓ _____

Working mode: ✓

Gateway using LLC Encap with Dynamic IP.

Gateway using LLC Encap with Static IP.

Gateway using Classical IP

Gateway using PPPoE

Gateway using PPPoA

Router using Classical IP

Modem using LLC Encaps.

PPP authentication:

Login Name: ✓ _____

Password: ✓ _____

3-2 Web-based User Interface

The NetComm ADSL Modem Router is designed to use a Web-based User Interface for configuration. Start your web browser and type `http://192.168.1.1` in the browser's *address box*. This address is the factory default IP Address of your NetComm ADSL Modem Router. Press “**Enter**”.

The “**Username and Password Required**” prompt box will appear. Leave the “**User Name**” empty and type “**admin**” (default password) for the “**Password**”. Click “**OK**”. The setup screen will load.

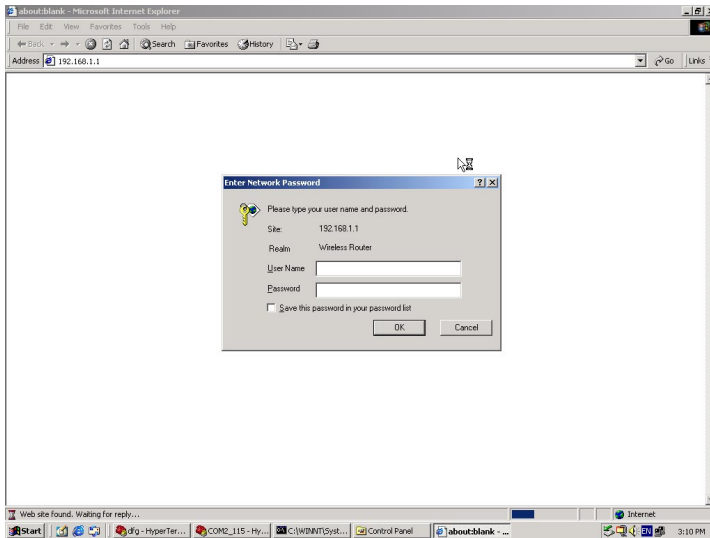

Note: *The password can be reset by restoring the factory defaults with the Reset button.*

3-3 Initial Configuration – Setup

The “**OnePage Setup**” screen is the first screen you will see when you access the router’s configuration. If the router has already been successfully installed and set up, this screen’s values will already be properly configured. Below is a description of each setting.

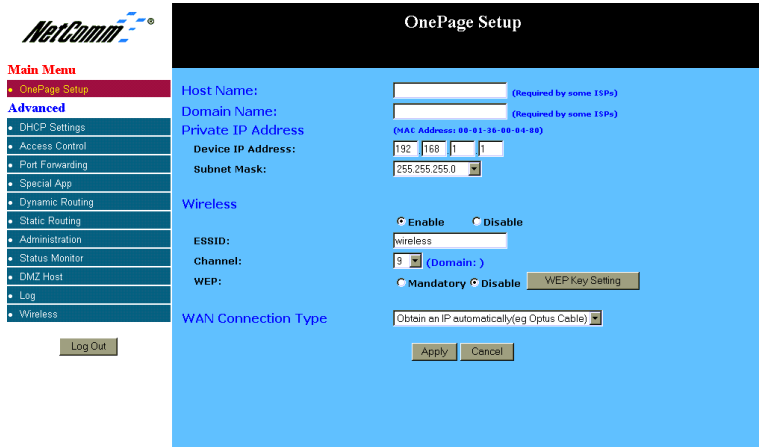

- **Host Name** This entry is required by certain ISPs.
- **Domain Name** This entry is required by certain ISPs.
- **Private IP Address** The Device IP Address and Subnet Mask of the router are used by the internal LAN. The default values are 192.168.1.1 for IP Address and 255.255.255.0 for Subnet Mask.
- **VC Setting** Enter the VPI and VCI values provided by your ISP. As for the Operation Mode, this ADSL Switch Router supports “**ANSI T1.413**”, “**G.dmt**”, and **G.lite**. You can choose one of those modes from the pop-down list if you exactly know which mode your ISP used. Otherwise, leave it as default setting, “**Auto**”.

WAN Connection Type

WAN Connection type is the way the ADSL Switch Router works with DSLAM equipped in your ISP side. This ADSL Switch Router supports seven connection types listed as below:

- Gateway using LLC Encaps. (Dynamic IP)
- Gateway using LLC Encaps. (Static IP)
- Gateway using Classical IP
- Gateway using PPPoE
- Gateway using PPPoA
- Router using Classical IP
- Modem using LLC Encaps.

Gateway, Router and Modem are different *working modes* that the ADSL Switch Router can use. It is highly recommend that you use the Gateway mode, which is NAT enabled. It not only allows LAN users to share a single IP Address, but also protects your LAN network from outside intruders. If the ADSL Switch Router is set to the Router mode or the Modem mode, all the PCs in the LAN will have to be assigned fixed IP Addresses. The Router mode allows users to specify which routing path data packets should take. If setting to the Modem mode, the Public IP Address setting is not necessary.

LLC Encaps, Classical IP, PPPoE, and PPPoA are different *connection modes* that are different protocols of making the initial session between your ADSL Switch Router and ISP's equipment. Your ISP may provide the information that which connection mode you should set. If you don't know which one to choose, you have to call your ISP to get this information.

Gateway using LLC Encaps. (Dynamic IP)

This connection type is the default setting of this ADSL Switch Router. Choose this setting if:

1. You want to employ NAT to share Internet access for all of your computers, as well as protect them for outside intruders.
2. Your ISP uses LLC Encapsulation and DHCP to assign IP addresses when you connect. (LLC encapsulation allows multiplexing of multiple protocols over a single ATM virtual connection (VC). You can find more information in the RFC 2684 standard.)

Gateway using LLC Encaps. (Static IP)

Choose this setting according if :

1. You want to employ NAT to share Internet access for all of your computers, as well as protect them for outside intruders.
2. Your ISP uses LLC Encapsulation and provides you with one or more IP addresses when you apply for the service. You can find more information in the RFC 2684 standard.

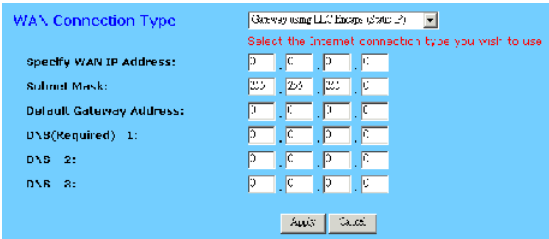

- **Specify WAN IP Address** Enter one IP address provided by your ISP.
- **Subnet Mask** Enter the subnet mask values provided by your ISP.
- **Default Gateway IP Address** Your ISP will provide you with the Default Gateway IP Address.
- **Domain Name Server (DNS)** Your ISP will provide you with at least one DNS IP Address. Multiple DNS IP settings are common. The first available DNS entry is used in most cases.

Gateway using Classical IP

Choose this setting to meet the following conditions:

1. You want to employ NAT to share Internet access for all of your computers, as well as protect them for outside intruders.
2. Your ISP uses **Classical IP** connection type (use LLC encapsulation and routing protocol) and provides you with one or more IP addresses when you apply for the service. You can find more information in the RFC 2684 standard.

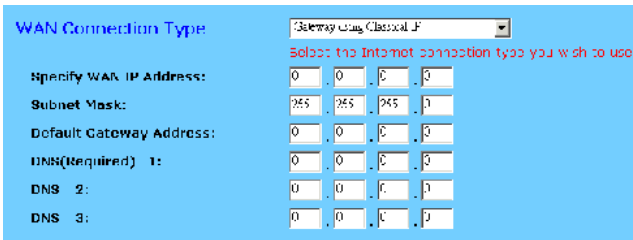

The screenshot shows the 'WAN Connection Type' configuration window. The dropdown menu is set to 'Gateway using Classical IP'. Below the dropdown, there is a red instruction: 'Select the Internet connection type you wish to use'. The configuration fields are as follows:

Specify WAN IP Address:	0	.	0	.	0	.	0
Subnet Mask:	255	.	255	.	255	.	0
Default Gateway Address:	0	.	0	.	0	.	0
DNS(Required) 1:	0	.	0	.	0	.	0
DNS 2:	0	.	0	.	0	.	0
DNS 3:	0	.	0	.	0	.	0

- **Specify WAN IP Address** Enter the IP address provided by your ISP.
- **Subnet Mask** Enter the subnet mask values provided by your ISP.
- **Default Gateway IP Address** Your ISP will provide you with the Default Gateway IP Address.
- **Domain Name Server (DNS)** Your ISP will provide you with at least one DNS IP Address. Multiple DNS IP settings are common. The first available DNS entry is used in most cases.

Gateway using PPPOE

Choose this setting if:

1. You want to employ NAT to share Internet access for all of your computers, as well as protect them for outside intruders.
2. Your ISP uses PPPoE as connection mode. You can find more information in the RFC 2516 standard.

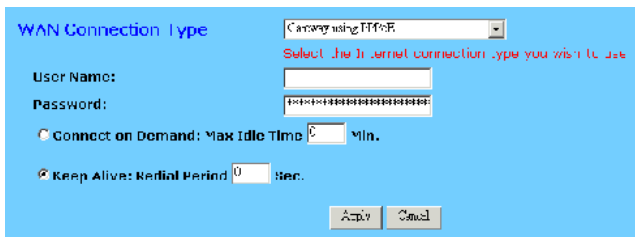

The screenshot shows the 'WAN Connection Type' configuration window. The dropdown menu is set to 'Gateway using PPPOE'. Below the dropdown, there is a red instruction: 'Select the Internet connection type you wish to use'. The configuration fields are as follows:

User Name:	<input type="text"/>
Password:	<input type="password"/>
<input type="radio"/> Connect on Demand: Max Idle Time	<input type="text" value="0"/> Min.
<input checked="" type="radio"/> Keep Alive: Redial Period	<input type="text" value="0"/> Sec.

Buttons: Apply, Cancel

- **User Name** Enter the user name your ISP provide to you.
- **Password** Enter the password your ISP provide to you.

- **Connect-on-demand** Is a utility to trigger the PPPoE session to connect if in a disconnected status when Internet access is being attempted. Choose “**Enable**” to make this function active, and enter the number of minutes you wish to wait after network idle time in the “**Max Idle Time**” location. This function is for PPPoE only.
- **Keep Alive** This function keeps your PPPoE connection always on even during a period of no WAN activity. In some situations the PPPoE session can not be restored immediately after disconnection because the ISP’s system may need time to restore. Check with your ISP to ascertain how much time is required before the router starts to re-build the PPPoE session and enter this into the “**Redial Period**” field.

Gateway using PPPOA

Choose this setting if:

1. You want to employ NAT to share Internet access for all of your computers, as well as protect them for outside intruders.
2. Your ISP uses **PPPoA** as its connection mode. You can find more information in the RFC 2684 standard.



- **User Name** Enter the user name your ISP provide to you.
- **Password** Enter the password your ISP provide to you.
- **Connect-on-demand** Is a utility to trigger the PPPoA session to connect if in a disconnected status when Internet access is being attempted. Choose “**Enable**” to make this function active, and enter the number of minutes you wish to wait after network idle time in the “**Max Idle Time**” location.
- **Keep Alive** This function keeps your PPPoA connection always on even it sites idle. However, in some situation, PPPoA session can not be built immediately after disconnection because the system on ISP site may need a little time to restore. You may need to check your ISP to get the information that how much time it need to wait before the router start to re-build the PPPoE session and fill it in the “**Redial Period**”.

Router using Classical IP

Choose this setting if:

1. You want this device acting as a router without NAT function.
2. Your ISP uses **Classical IP** connection type (use LLC encapsulation and routing protocol) and provides you one or more IP addresses when you apply for the service. You can find more information in the RFC 2684 standard.

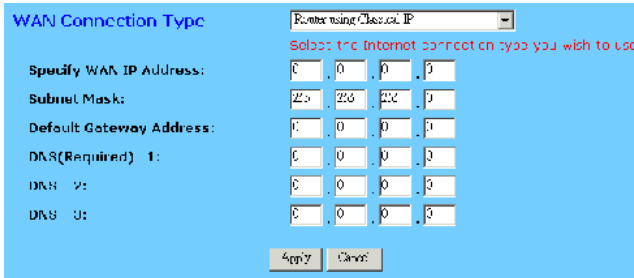

The screenshot shows a configuration window titled "WAN Connection Type". A dropdown menu is set to "Router using Classical IP". Below the dropdown, there is a red instruction: "Select the Internet connection type you wish to use". The form contains several input fields for IP configuration:

- Specify WAN IP Address: 0 . 0 . 0 . 0
- Subnet Mask: 255 . 255 . 255 . 0
- Default Gateway Address: 0 . 0 . 0 . 0
- DNS(Required) 1: 0 . 0 . 0 . 0
- DNS 2: 0 . 0 . 0 . 0
- DNS 3: 0 . 0 . 0 . 0

At the bottom, there are "Apply" and "Cancel" buttons.

- **Specify WAN IP Address** Enter the IP address provided by your ISP.
- **Subnet Mask** Enter the subnet mask values provided by your ISP.
- **Default Gateway IP Address** Your ISP will provide you with the Default Gateway IP Address.
- **Domain Name Server (DNS)** Your ISP will provide you with at least one DNS IP Address. Multiple DNS IP settings are common. The first available DNS entry is used in most cases.

Note: *You have to set public IP address for each of your LAN PCs if you select this connection type.*

Modem using LLC Encaps.

Choose this setting if:

1. You want this device acting as an ADSL modem. (i.e. when being plugged into another broadband router or a PC running your ISP's software)
2. Your ISP uses LLC encapsulation.

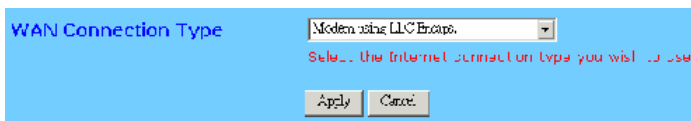

The screenshot shows a configuration window titled "WAN Connection Type". A dropdown menu is set to "Modem using LLC Encaps.". Below the dropdown, there is a red instruction: "Select the Internet connection type you wish to use". At the bottom, there are "Apply" and "Cancel" buttons.

Your ISP may use DHCP to provide IP address or provide you one or more IP addresses, as well as asking use PPPoA or PPPoE connection modes when you apply for the service. However, as you choose to make this device act as an modem, you have to know how to configure your computers.

When you have properly configured the Setup page, click "**Apply**". Your Router will then attempt to connect to the Internet. If you experience problems, please refer to the trouble shooting section in Chapter 6 before contacting NetComm Technical Support.

Chapter 4: Advanced Applications

This chapter provides information on how to set up and use the advanced features of your NetComm ADSL Modem Router.

4-1 DHCP Configuration

A DHCP (Dynamic Host Configuration Protocol) Server can automatically assign IP Addresses to each computer in your network. Unless you already have a DHCP Service on your LAN, it is highly recommended that you set your router to act as a DHCP server.

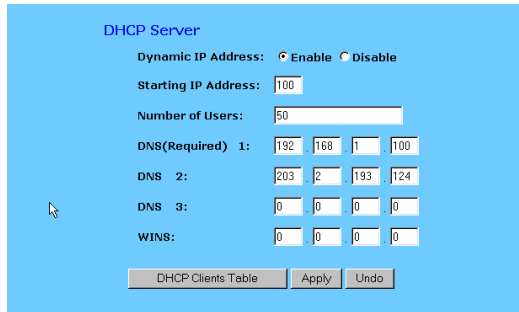

Note: *The DHCP Server can support a maximum pool of 253 IP Addresses.*

- **Dynamic IP Address** Select “**Enable**” to set your Router to act as a DHCP server. If you already have a DHCP server on your network, set the router’s DHCP option to “**Disable**”.
- **Starting IP Address** Enter a numerical value, from 2 to 254, for the DHCP server to start at when assigning IP Addresses.
- **Number of Users** Enter the maximum number of computers that you want the DHCP server to assign IP Addresses to, with the absolute maximum being 253.
- **DNS1, 2, 3** Enter the DNS numbers you wish to be assigned to DHCP clients.
- **WINS** Enter the WINS number you wish to be assigned to DHCP clients.
- **DHCP Clients Table** Click the DHCP Clients Table button to show current DHCP client information.

4-2 Access Control

The Access Control feature allows administrators to block certain users from accessing the Internet or specific applications. Before using this function, the network computers which you want to control the access limitation should be assigned fixed IP Addresses.

IP Access Setting

Network administrators can restrict access of up to five groups of specified network users/computers.

[IP Access Setting](#) | [URL Access Setting](#) | [MAC Access Setting](#)

IP Access Settings
 Insert the LAN IPs and the port numbers you wish to be blocked.

Protocol	Filter Group(1-5)/LAN IP Range	Blocked Port Range
Both	192.168.1.0 ~ 0	0 ~ 0
Both	192.168.1.0 ~ 0	0 ~ 0
Both	192.168.1.0 ~ 0	0 ~ 0
Both	192.168.1.0 ~ 0	0 ~ 0
Both	192.168.1.0 ~ 0	0 ~ 0

- **Protocol** Select the protocol type as “TCP” or “UDP” from the drop down box. If you are not sure which one to choose, select “Both”.
- **Filter Group/LAN IP Range** Enter the range of IP addresses which you want to have the same access limitation (a group).
- **Block Port Range** Enter the range of port numbers which are used by the applications you wish to be blocked. (For example 23 for Telnet)

Here is an example for IP Access Setting. Enter the range of **51~80** in the “**Filter Group**” column and **20~80** in the “**Block Port Range**” column, then click the “**Apply**” button. As a result, the user’s computers which have IP Addresses in the range of 192.168.1.51 to 192.168.1.80 will not be able to use the applications which use port numbers from 20 to 80, such as FTP, Telnet and web browsing.

URL Access Settings

To change to **URL Access Settings**, select from the menu at the top of the page.

[IP Access Setting](#) | [URL Access Setting](#) | [MAC Access Setting](#)

URL Access Settings
 You can use this function to restrict access to listed URL's or give access ONLY to listed URL's.

URL Access Limit Enable Disable

Website Access Allow Block

URL List:

Site 1:	<input type="text"/>	<input type="button" value="Delete"/>
Site 2:	<input type="text"/>	<input type="button" value="Delete"/>
Site 3:	<input type="text"/>	<input type="button" value="Delete"/>
Site 4:	<input type="text"/>	<input type="button" value="Delete"/>
Site 5:	<input type="text"/>	<input type="button" value="Delete"/>
Site 19:	<input type="text"/>	<input type="button" value="Delete"/>
Site 20:	<input type="text"/>	<input type="button" value="Delete"/>

This function allows network administrators to restrict access to listed URLs or give access ONLY to listed URLs.

- **URL Access Limit** Check “**Enable**” or “**Disable**” to make this function active or inactive.
- **Website Access** Check “**Allow**” to allow users on the network to access a specific website listed on the location only. In contrast, to restrict users on the network access to the websites listed, check “**Block**” in this item.
- **URL List** Enter the website addresses to be accessed/blocked in the locations field. Up to twenty website addresses can be entered.
- **Show URL Log** allows network administrators to check the URL access records. Click the button of “**Show URL Log**” to go to the URL Filter Log table. This table lists the users/computers by their IP Addresses, the access status, and their URL Access destinations.

Private MAC Filter

This function allows network administrators to insert the MAC addresses that need to be managed.

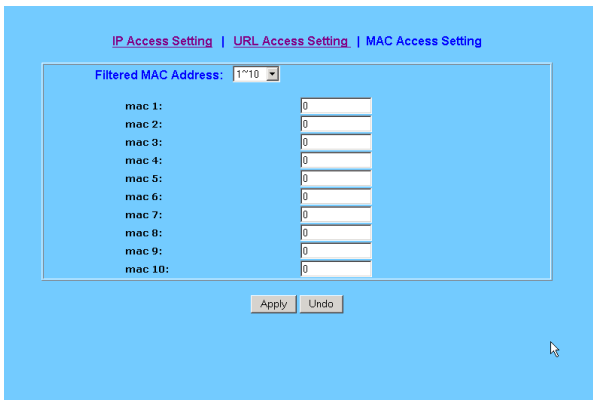

[IP Access Setting](#) | [URL Access Setting](#) | [MAC Access Setting](#)

Filtered MAC Address: 1~10

mac 1:	0
mac 2:	0
mac 3:	0
mac 4:	0
mac 5:	0
mac 6:	0
mac 7:	0
mac 8:	0
mac 9:	0
mac 10:	0

- **Filtered MAC Address** There are fifty sets divided into five groups of ten in this function. You can choose each group by selecting from the drop-down list. Enter the MAC addresses of the computers you wish to block in the columns, and then those users/computers cannot access Internet at all.

Click “**Apply**” after making any changes.

4-3 Port Forwarding Settings

The Port Forwarding Settings application allows you to set up to ten public ports, such as a HTTP (web), SMTP (email), FTP, etc. that can be accessed by external users of the Internet. Each service is forwarded to a dedicated network computer (server) configured with a fixed LAN IP Address. Although the internal service addresses are not directly accessible to the external user, the NetComm ADSL Modem Router is able to redirect requests to the appropriate internal IP Address/server. To use this application, it is recommended you use a fixed Public IP Address from your ISP.

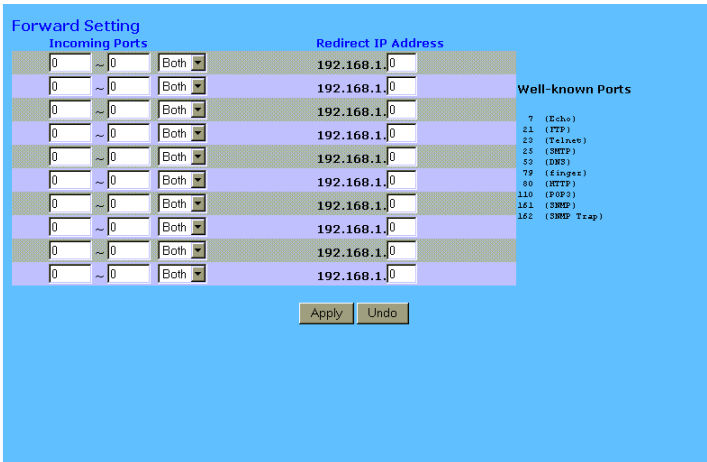

Incoming Ports			Redirect IP Address
0	Both	Both	192.168.1.10
0	Both	Both	192.168.1.10
0	Both	Both	192.168.1.10
0	Both	Both	192.168.1.10
0	Both	Both	192.168.1.10
0	Both	Both	192.168.1.10
0	Both	Both	192.168.1.10
0	Both	Both	192.168.1.10
0	Both	Both	192.168.1.10
0	Both	Both	192.168.1.10

Well-known Ports

- 7 (Echo)
- 21 (FTP)
- 23 (Telnet)
- 25 (SMTP)
- 53 (DNS)
- 79 (Finger)
- 80 (HTTP)
- 110 (POP3)
- 143 (IMAP)
- 162 (SNMP Trap)

Apply Undo

Note: Your NetComm ADSL Modem Router supports only one forward to one IP Address for each port (service).

- Set up individual network computers to act as servers and configure each with a fixed IP Address.
- In the “One Page Setup” screen, ensure the “**Private IP Address**” is set to the NetComm ADSL Modem Router’s default setting of 192.168.1.1. If a fixed Public IP Address is to be used, select “**Specify an IP address**” and enter the IP Address and other necessary information provided by your ISP.
- **Incoming Ports** - Enter the desired service port numbers in the “**Ports**” fields. You can specify the protocol type as “**TCP**” or “**UDP**” from the drop-down list. If you are not sure which one to select, choose “**Both**”. A selection of commonly used port numbers is provided on the right of this screen.
- **Redirect IP Address** - Enter the appropriate IP Addresses of the service computers in the “**Redirect IP Address**” locations.

Example: If the service port number **80~80** (representing an HTTP web address) is entered in “**Ports**” and **192.168.1.100** is entered in “**Redirect IP Address**”, then all HTTP requests from external Internet users will be directed to port 80 of the computer/server with the 192.168.1.100 fixed IP Address.

Here is a list of the protocols and port ranges that are used by some common applications.

Note: Port 8080 on the Public IP Address is used for Remote Management and can not be redirected if remote management is enabled.

Application	Protocol	Port Range
FTP Server	TCP	21
Half Life	UDP	6003, 7002, 27010, 27015, 27025
MSN Messenger	TCP	6891-6900 (File-send)
	TCP	1863
	UDP	1863
	UDP	5190
	UDP	6901 (Voice)
PC Anywhere host	TCP	6901 (Voice)
	TCP	5631
Quake 2	UDP	5632
	UDP	27910
Quake III	UDP	27660 (first player) "C:\Program Files\Quake III Arena\quake3.exe" +set net_port 27660
	UDP	27661 (second player)
	TCP	27661 (second player)
Telnet Server	TCP	23
Web Server	TCP	80

4-4 Special Application

Some applications use multiple TCP/UDP ports to transmit data. Due to the use of NAT in the router, these applications may not work. Port Triggering allows these applications to work properly.

Existing Special Applications

Application Name	Outgoing Port Range	Incoming Port Range
1: <input type="text"/>	<input type="text"/> ~ <input type="text"/>	<input type="text"/> ~ <input type="text"/>
2: <input type="text"/>	<input type="text"/> ~ <input type="text"/>	<input type="text"/> ~ <input type="text"/>
3: <input type="text"/>	<input type="text"/> ~ <input type="text"/>	<input type="text"/> ~ <input type="text"/>
4: <input type="text"/>	<input type="text"/> ~ <input type="text"/>	<input type="text"/> ~ <input type="text"/>
5: <input type="text"/>	<input type="text"/> ~ <input type="text"/>	<input type="text"/> ~ <input type="text"/>
6: <input type="text"/>	<input type="text"/> ~ <input type="text"/>	<input type="text"/> ~ <input type="text"/>
7: <input type="text"/>	<input type="text"/> ~ <input type="text"/>	<input type="text"/> ~ <input type="text"/>
8: <input type="text"/>	<input type="text"/> ~ <input type="text"/>	<input type="text"/> ~ <input type="text"/>
9: <input type="text"/>	<input type="text"/> ~ <input type="text"/>	<input type="text"/> ~ <input type="text"/>
10: <input type="text"/>	<input type="text"/> ~ <input type="text"/>	<input type="text"/> ~ <input type="text"/>

Note: Only one computer can use each Port Triggering setting at any time.

- **Application Name** Enter the name of the application you wish to configure in the Application Name column to identify this setting. This is just a label and does not govern the function of the settings.
- **Outgoing Port Range** Enter the port number or range of numbers this application uses when it sends packets outbound. The Outgoing Control port numbers act as the trigger. When the NetComm ADSL Modem Router detects the outgoing packets with these port numbers, it will allow the inbound packets with the Incoming Port Numbers that you set in the next column to pass through the NetComm ADSL Modem Router.
- **Incoming Control** Enter the port number or range of numbers the inbound packets carry.

Click “Apply” after making any changes.

Followings are port numbers list of some popular application:

Application	Outgoing Control	Incoming Data
Battle.net	6112	6112
DialPad	7175	51200, 51201,51210
ICQ	4000	4000
ICU II	2019	2000-2038, 2050-2051, 2069, 2085,3010-3030
IRC	6667	531, 6666, 6667
MSN Gaming Zone	47624	2300-2400, 28800-29000
PC to Phone	12053	12120,12122, 24150-24220
Quick Time4	554	6970-6999
wowcall	8000	4000-4020

4-5 Dynamic Routing

The Dynamic Routing feature allows your NetComm ADSL Modem Router to exchange routing information with other routers in the network. Enabling this feature is likely to enhance performance of your NetComm ADSL Modem Router.

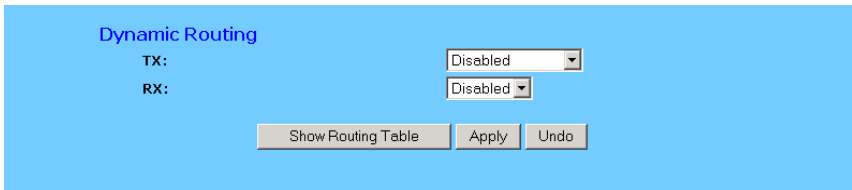

- **TX** From the drop-down list, select one of the routing information types, “RIP-1”, “RIP-1 Compatible”, or “RIP-2”, to enable the “TX” (transmit) function. “RIP-1” is the protocol used by older routers and newer routers should use “RIP-2”. “RIP-1 Compatible” serves to broadcast RIP-1 and multicast RIP-2.
- **RX** From the drop-down list, select one of the routing information types, “RIP-1” or “RIP-2”, to enable the “RX” (receive) function.

Click “Apply” after making any changes.

4-6 Static Routing

The Static Routing feature allows computers that are connected to the NetComm ADSL Modem Router directly or through a hub/switch (on the immediate LAN) to communicate with other computers in the respective LAN segment which are connected to the NetComm ADSL Modem Router through another router (destination LAN). Up to 20 route entries may be entered into the NetComm ADSL Modem Router. The diagram below gives an example of the physical connections required to use Static Routing.

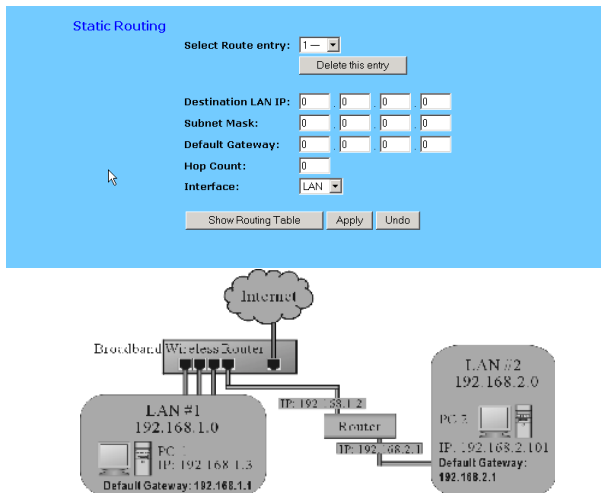

In the above diagram, PC2 in LAN#2 is connected to the NetComm ADSL Modem Router via another router while PC1 in LAN#1 is connected to the NetComm ADSL Modem Router directly. Without configuring the Static Routing function, the two computers would not be able to communicate with each other.

- **Select Route entry** Select the route entry number from 1 to 20 that you wish to configure.
- **Destination LAN IP** and **Subnet Mask** Enter the IP Address and Subnet Mask of the destination LAN that the immediate LAN is to communicate with. Taking the above diagram as an example, enter **192.168.2.0** in the “**Destination LAN IP**” field and **255.255.255.0** in the “**Subnet Mask**” field.
- **Default Gateway** Enter the IP Address of the router that forwards data packets to the destination LAN. For the above example, enter **192.168.1.2** in the “**Default Gateway**” field.
- **Hop Count** Enter the number of hops required between the LANs to be connected. The Hop Count represents the “cost” of the routing transmission. The default value is 1.
- **Interface** Choose “LAN” if the Destination LAN is on your Router’s LAN side and choose “WAN” if the Destination LAN is on the Router’s WAN side.

Referring back to the above diagram, with proper setting, PC1 would be able to access LAN 1, LAN 2 and the Internet while PC2 can only access LAN 2 and LAN 1.

Click “Apply” after making any changes.

4-7 Administration Settings

This feature allows the administrator to manage the NetComm ADSL Modem Router by setting certain parameters. For security reasons, it is strongly recommended that you set a Password and SNMP communities so that only authorized persons are able to manage your NetComm ADSL Modem Router. If the **“Password”** is left blank, all users on your network can access the router simply by entering the unit’s IP Address into their web browser’s location window.

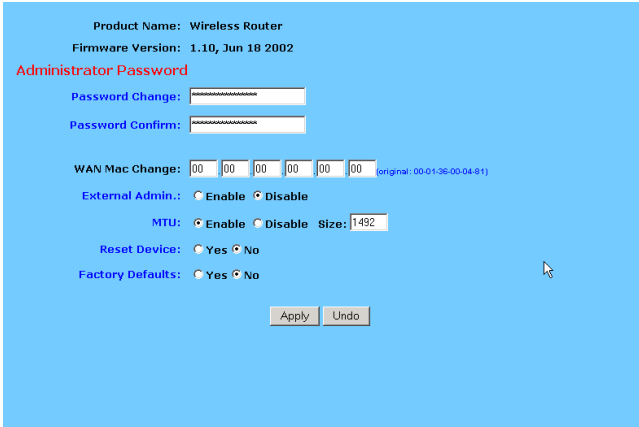

- **Firmware Version** This field shows the installed version of the firmware.
- **Administrator Password** Enter the password you want to use into the **“Password Change”** field and re-enter it into the **“Password Confirm”** field for confirmation. Be sure that the password is less than 64 characters long and without any spaces.
- **WAN MAC Change** The WAN MAC address can be changed from the original values if necessary. Some ISPs require users to change the WAN MAC address to a registered one when users change their access equipment.
- **External Admin** Check **“Enable”** to allow you to configure the NetComm ADSL Modem Router from WAN side. To access the setting page from external side, enter **“http://<WAN IP Address>:8080”** into the web browser address column and press the **“Enter”** key.
- **MTU** Check **“Enable”** if you want to set the limitation of maximum packet size incoming and outgoing the router. Enter the maximum packet size you wish to set in the **“Size”** column. This can assist with the transmission of emails with attachments, etc.
- **Reset Device** Select **“Yes”** if you want to clear connections, reboot, and re-initialize the unit without affecting any of your configuration setting.
- **Factory Defaults** Select **“Yes”** if you want to return all the router’s current settings to their factory default settings.

Note: *Do not restore to the factory defaults unless it is absolutely necessary.*

Click **“Apply”** to make any changes.

4-8 Status Monitor

This screen shows the router's current status. All of the information provided is read-only.

Login

WAN(Internet)

Public IP Address	172.16.1.220
Public Subnet Mask	255.255.255.0
Default Gateway IP Address	172.16.1.4
Domain Name Server 1	172.16.1.22
Domain Name Server 2	0.0.0.0
Domain Name Server 3	0.0.0.0
DHCP Server	172.16.1.8
DHCP Leased Time	6 days 23:59:58
DHCP Time Remaining	0:09:58

LAN(Local)

Private IP Address	192.168.1.1
Subnet Mask	255.255.255.0

- **Login** This column shows the login information of your WAN connection. You can manually initiate a connection or a disconnection by clicking the buttons. However, if you initiate disconnection here, the **“Connect-on-Demand”** will not function until the connection button is clicked. Note that the Login won't show any information if you select **“Obtain IP automatically”** or **“Static IP”** in the **“OnePage Setup”** page.
- **WAN (Internet)** This section shows the IP settings status of the router as seen by external users of the Internet. If you select **“Get IP Address Automatically”**, **“PPPoE”**, or **“PPTP”** in OnePage Setup, the **“IP Address”**, **“Subnet Mask”**, **“Default Gateway”**, and **“Domain Name Server”** (DNS) will show the information received from the DHCP server or ISP currently being used. If you select **“Static IP”** in the **“One Page Setup: Public IP Address”**, the information will be the same as your input.

DHCP Release: Click this button to eliminate the IP address obtained from the DHCP server.

DHCP Renew: Click this button to re-acquire the IP address from the DHCP server.

Note: *The “DHCP Release” and “DHCP Renew” button only show up when you select “Get IP Address Automatically” in the OnePage Setup.*
- **LAN (Local)** This section displays the current **“Private IP Address”** and **“Subnet Mask”** of the router, as seen by users of your internal network.
- **DHCP Clients Table** If the router is setup to act as a DHCP server, the LAN side IP Address distribution table will appear when this button is selected.

4-9 DMZ Host

The DMZ Host application allows unrestricted 2-way communication between a single LAN computer and other Internet users or servers. This application is useful for supporting special-purpose services such as video-conferencing and gaming, which require proprietary client software and/or unrestricted 2-way user communication. To use this application, you should have a fixed Public IP Address from your ISP.

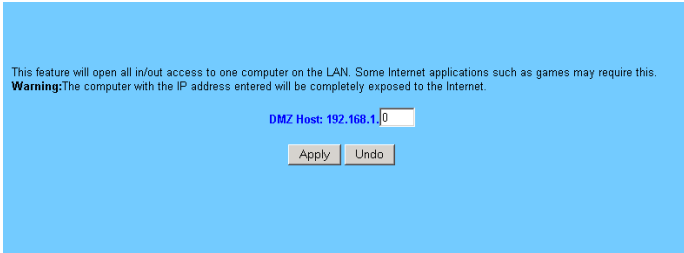

Note: In order to provide unrestricted access, the Firewall provided by the NetComm ADSL Modem Router to protect this port is disabled, thus creating a potentially serious security risk. It is recommended that this application should be disabled when it is not in use by entering “0” in the “DMZ Host” field.

1. Before setting up a LAN computer to act as a DMZ Host, configure it with a fixed IP Address.
2. In the “**One Page Setup**” screen, ensure the Private IP Address is set to the NetComm ADSL Modem Router’s default setting of **192.168.1.1**. In the Public IP Address area, select “**Specify an IP Address**”, then enter the IP Address and other necessary information provided by your ISP.
3. Click “**DMZ Host**” from the Advanced Menu. Enter the fixed IP Address of the Exposed Host computer in the “**DMZ Host**” IP Address location. Remember, entering “**0**” will disable this application.
4. Click “**Apply**”.

4-10 Log

The Log application allows the administrator to trace Internet access. You can send the record to specific LAN computers for remote monitoring, but can also watch the incoming (WAN to LAN) and outgoing (LAN to WAN) traffic in the “**Log Settings**” page.

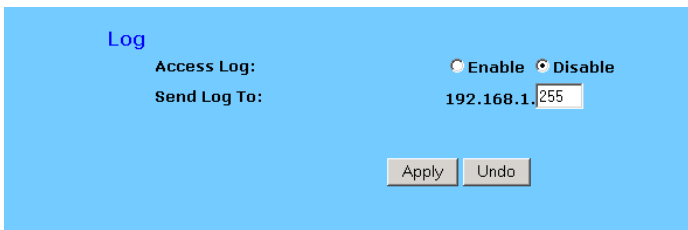

- **Access Log** Set to **Enable** if you want to activate this function.
- **Send Log To** Enter the IP address of the computer that you want to send the Log information to.
- **Incoming Access log** Click this button to go to the incoming (WAN to LAN) traffic log table. This Table records information on the last fifty incoming packets, including source IP address, destination IP address, and port number.
- **Outgoing Access log** Click this button to go to the outgoing (LAN to WAN) traffic log table. This Table records information on the last fifty outgoing packets, including source IP addresses, destination IP addresses, and port numbers.

Click “**Apply**” after making any changes.

4-11 VPN Passthrough

Virtual Private Networking (VPN) is a system which allows remote networks to privately exchange data over an existing public network (usually the Internet). One VPN client can be used to make one VPN connection (Tunnel) to a VPN Server on the Internet. The NetComm ADSL Modem Router supports one single session VPN Passthrough (PPTP or L2TP/IPSec). There is no configuration necessary for VPN Passthrough.

Chapter 5: Macintosh Setup

This chapter provides information on using Macintosh computers in your network. The instructions given here are for system software version 8.0 or above, which comes with the TCP/IP Protocol preloaded and supports DHCP Addressing.

5-1 Hardware Connections

Connect your Macintosh computer to your NetComm ADSL Modem Router. If you have a newer computer, there will be a 10Base-T Ethernet port on the back. Older computers will need to have an Ethernet card installed. Refer to your computer's User Manual for instructions on Ethernet card installation.

5-2 Computer Network Configuration

It is assumed that your computer's system software already has TCP/IP installed. You may manually configure your computer with a fixed IP Address (for example 192.168.1.2) or have an IP Address dynamically assigned to it by the NetComm ADSL Modem Router's DHCP server.

5-2.1 Dynamic IP Addressing using DHCP Server.

1. From the **"Apple"** menu, select **"Control Panel"** and click on **"TCP/IP"**.
2. In the **"TCP/IP (A New Name For Your Configuration)"** window, select **"Ethernet"** in the **"Connect via"** location from the drop-down list.
3. In the **"Setup"** area:
 - Select **"Using DHCP Server"** in the **"Configure"** location from the drop-down list.
 - No other data needs to be entered.
 - Close the window.
4. Click **"Save"** from the file menu, then **"Quit"** TCP/IP.
5. Restart the computer.

5-2.2 Manual Configuration of Fixed IP Addresses

1. From the **"Apple"** menu, select **"Control Panel"** and click on **"TCP/IP"**.
2. In the **"TCP/IP (A New Name For Your Configuration)"** window, select **"Ethernet"** in the **"Connect via"** location from the drop-down list.
3. In the **"Setup"** area:
 - Select **"Manually"** in the **"Configure"** location from the drop-down list.
 - In the **"IP Address"** location, enter the IP Address that you want to assign to the computer (for example 192.168.1.2) .
 - Enter **"255.255.255.0"** in the **"Subnet Mask"** location.
 - Enter **"192.168.1.1"** (the NetComm ADSL Modem Router's default IP Address) in the **"Router Address"** location.

- Enter the ISP's IP Address in the **"Name Server"** location if your ISP has provided the information. (This is the DNS address provided by your ISP.)
 - Close the window.
4. Click **"Save"** from the file menu then **"Quit"** TCP/IP.
 5. Restart the computer.

5-3 NetComm ADSL Modem Router Configuration

To configure your NetComm ADSL Modem Router, launch your Web Browser and follow the instructions given in Chapter 3: Internet Access, section 3.3.

5-4 Adding NetComm ADSL Modem Router to an Existing Network

If the NetComm ADSL Modem Router is to be added to an existing Macintosh computer network, the computers will have to be configured to connect to the Internet via the NetComm ADSL Modem Router.

1. From the **"Apple"** menu, select **"Control Panel"** and click on **"TCP/IP"**.
2. From the **"File"** menu, select **"Configurations"** and select your existing network configuration. Click **"Duplicate"**.
3. Rename your existing configuration. Click **"OK"**, and **"Make Active"**.
4. In the Setup area:
 - Select **"Manually"** in the **"Configure"** location from the drop-down list.
 - In the **"IP Address"** location, enter the IP Address that you want to assign to the computer (for example 192.168.1.2) .
 - Enter **"255.255.255.0"** in the **"Subnet Mask"** location.
 - Enter **"192.168.1.1"** (the NetComm ADSL Modem Router's default IP Address) in the **"Router Address"** location.
 - Enter the ISP's IP Address in the **"Name Server"** location if your ISP has provided the information.
 - Close the window.
5. Click **"Confirm"**. TCP/IP is now configured for manual IP Addressing.
6. Configure your NetComm ADSL Modem Router (see 5.3 above).

Chapter 6: Trouble Shooting

This chapter provides solutions to problems you may encounter during installation and operation of your NetComm ADSL Modem Router.

Hardware

T: The Power LED is off.

Check the power cable is properly connected to the NetComm ADSL Modem Router, the power adapter and the socket.

T: The LAN Link LED is off.

Check the computer, hub or switch is properly connected to the NetComm ADSL Modem Router.

Check the computer's Ethernet card is properly installed.

Check the UTP cable connecting the computer to the Router is connected. This cable should **not** be a crossover cable.

T: The DIAG LED stays lit.

The DIAG LED should light up when the device is first powered up to indicate it is checking for proper operation. After a few seconds, the LED should go off. If it stays on, the device is experiencing a problem. Please contact your dealer.

T: Why can't I configure the NetComm ADSL Modem Router?

First, check whether the NetComm ADSL Modem Router is properly installed or not, including the LAN and WAN connections, and all devices' power.

Next, check the IP configuration of your computer :

- For Windows 95/98 users: run **Winipcfg.exe** or **Winipcfg** from "**Run**" on the "**Start**" menu. If there are no IP addresses, click "**Release All**" and then click "**Renew All**" to get an IP address.

For Windows NT 4.0/2000/XP users: Open a command prompt and run **IpConfig**.

- Ensure that your computer and the NetComm ADSL Modem Router are on the same network segment. If you are not sure, initiate the DHCP function and let the computer get an IP address automatically from the router.
- Ensure that your computer is using an IP Address within the range 192.168.1.2 to 192.168.1.253 and thus compatible with the NetComm ADSL Modem Router's default IP address of 192.168.1.1
- Finally, use *Ping* command in MS-DOS mode to verify the network connection:
 - *Ping* 127.0.0.1 to check the TCP/IP stack of your computer.

- *Ping* the Router's IP address (Default: 192.168.1.1) to check for IP connectivity between your computer and the Router.

Note: *If you are not able to get to the web configuration screen for the NetComm ADSL Modem Router, make sure that you disable the proxy setting within your Internet browser and set your browser to access the Internet via the LAN.*

T: What can I do if I have forgotten the password for NetComm ADSL Modem Router?

You have to reset the Router back to its factory default setting by pushing the Reset button for over 3 seconds.

Note: *You will lose all previous settings.*

T: I cannot access my ISP's home page, why?

Some ISPs (such as Telstra BigPond) require their host name be specifically configured into your computer before you can surf their local web pages. If you are unable to access your ISP's home page, enter your ISP's Domain Name into the OnePage Setup (3-3) to enable all computers in your LAN to access it. If you only want to allow computers to access these home pages, open the TCP/IP Properties window (2-4) on these computers, click open the **"DNS Configuration"** tab and enter your ISP's Domain Name in the **"Domain Name Search Suffix"** location.

Client Side (Computers)

T: I can't browse the Internet via the NetComm ADSL Modem Router

Ensure your computer can ping or access the Router. See the previous section entitled **"Why can't I configure the NetComm ADSL Modem Router"** for more information.

Check the status page of the Router to ensure connection to your ISP has been established.

T: I get a time out error when I enter a URL or IP address.

Check if other computers on the LAN are experiencing the same problem. If not, ensure the computer's IP settings are correct (IP Address, Subnet Mask, Gateway IP Address and DNS).

Check the NetComm ADSL Modem Router's settings are correct (3-3).

Appendix A: Frequently Asked Questions

Q: What is the maximum number of IP Addresses the NetComm ADSL Modem Router can support?

The NetComm ADSL Modem Router can support up to 253 IP Addresses in the range of 192.168.1.2~192.168.1.254.

Q: Where should the NetComm ADSL Modem Router be installed on the network?

In a typical environment, the NetComm ADSL Modem Router should be installed between the ISP and your LAN. Connect the NetComm ADSL Modem Router to the phone jack which supplies the ADSL signal, and connect your computers to the RJ45 jack on the LAN side.

Q: Does the NetComm ADSL Modem Router support IPX or AppleTalk?

No. The NetComm ADSL Modem Router was designed to provide a multiple user LAN with shared Internet access and supports only the TCP/IP Protocol. If your Novell or Apple system is configured with TCP/IP, the NetComm ADSL Modem Router can support them.

Q: Does the NetComm ADSL Modem Router support 100Mb Ethernet?

Yes, the NetComm ADSL Modem Router supports both 10Mb & 100Mb Ethernet on the LAN side, but only 10Mb on the WAN side.

Q: What is “NAT” and what is it used for?

The Network Address Translation (NAT) Protocol translates multiple IP Addresses on a private LAN into a single public IP Address that is accessible to the Internet. NAT not only provides the basis for multiple IP Address sharing but also provides security, since the multiple IP Addresses of LAN computers are never transmitted directly to the Internet.

Q: How can NetComm ADSL Modem Router share single user account to multiple users?

The NetComm ADSL Modem Router combines the following technologies to enable this function.

NAT (Network address translation): NAT is a technology which can create a private network domain behind a public IP. It is usually used as a firewall. It can also be used when there are not enough IP Addresses.

DHCP (Dynamic host configuration protocol): DHCP is a protocol to assign IP Addresses to internal computers automatically. It can save a lot of IP Address configuration. This protocol is supported by Windows 95/NT, Mac OS, and many other popular OS.

DNS (Domain name service): DNS is a protocol which translates Domain Names to IP addresses that an Internet host can handle. Addressing system using Domain names, like www.yahoo.com, is easier to use than its IP address, 204.71.177.70.

Q: What operating systems does NetComm ADSL Modem Router series support?

The NetComm ADSL Modem Router uses standard TCP/IP protocol. It can be operated as long as you have TCP/IP protocol installed on your operating system (For example: Windows 9x, Windows NT, Windows 2000, Windows XP, etc.)

Q: Can I use multiple E-mail accounts if I use NetComm ADSL Modem Router?

Yes, you can. Some people think having one Internet account means that they can have only one E-mail account. However, E-mail is set by mailbox accounts and different to the account you use to connect to your ISP. If you want more E-mail accounts, you can contact with your ISP or you can browse the Internet to apply for free E-mail account.

Q: Can Internet users access LAN computers?

The NetComm ADSL Modem Router uses NAT to route all in/out band packets. All external users can only see the IP of the NetComm ADSL Modem Router but cannot access LAN computers. The LAN computers are well protected with the NetComm ADSL Modem Router's natural firewall (NAT). You can allow Internet users access to specific computers by using the Port Forwarding, DMZ Host and Special Application options.

Q: When should I use DMZ host?

Enable DMZ host when you want to have unrestricted communication between your computer and the Internet, for example, playing Internet game (i.e. Ages of Empire) or having multimedia conference (i.e. NetMeeting).

Q: Does the NetComm ADSL Modem Router support PPTP of VPN packets pass through?

Yes. The NetComm ADSL Modem Router supports single session PPTP pass through.

Q: Does the NetComm ADSL Modem Router series support IPsec?

Yes. The NetComm ADSL Modem Router supports single session IPsec pass through.

Appendix B: Technical Specifications

Standards Compliance

IEEE 802.3 10BASE-T

IEEE 802.3u 100BASE-TX

Interface

One 10Mbps Ethernet RJ45 port on WAN

Four 10/100Mbps auto-sensing Ethernet RJ-45 ports and one uplink port on LAN

Management

Web-based UI Management

LED Display

Power

DIAG

Link/Activity for both WAN and LAN port(s)

Full Duplex/Collision for LAN ports

Environment

Operation Temperature: 0 ~ 45 degrees C

Storage Temperature: -20 ~ 70 degrees C

Humidity: 0 ~ 90% non-condensing

Dimension

145 (L) x 260 (W) x 38 (H) mm

Power

External, DC 5V, 2.5A

Mounting

Desktop

Wall-mounting

Appendix C: Glossary

10Base-T / 100Base-T

The adaptation of the Ethernet standard for Local Area Networks (LANs). 10Base-T uses a twisted pair cable with maximum lengths of 100 meters and transmits data at 10Mbps maximum. 100Base-T is similar, but uses two different twisted pair configurations and transmits at 100Mbps maximum.

Ad-hoc Network

Also known as the peer-to-peer network, an ad-hoc network allows all computers participating in a wireless network to communicate each other without an AccessPoint.

Adapter

A device that makes the connection to a network segment, such as Ethernet and modem cards.

ADSL

Asymmetric Digital Subscriber Line (ADSL), as its name indicates, is an asymmetrical data transmission technology with higher traffic rate downstream and lower traffic rate upstream. ADSL technology satisfies the bandwidth requirements of applications which demand “asymmetric” traffic, such as web surfing, file downloads, and telecommuting.

ATM

Asynchronous **T**ransfer **M**ode is a network technology supports real time voice, video, and data transmission. The topology uses switches that establish a logical circuit from end to end, which guarantees quality of service (QoS). ATM works by transmitting all traffic as fixed-length, 53-byte cells. This fixed unit allows very fast switches to be built ATM is widely used as a backbone technology in carrier networks and large enterprises. ATM is highly scalable and supports transmission speeds of 1.5, 25, 100, 155, 622, 2488 and 9953 Mbps. ATM is also running as slow as 9.6 Kbps between ships at sea.

Bandwidth

The amount of data that can be transmitted in a fixed amount of time.

Browser

A software application used to locate and display Web pages. Examples include Netscape Navigator and Microsoft Internet Explorer.

BSS

BSS is the acronym of Basic Service Set that is consisted a wireless access point and a group of wireless client computers.

Communications Protocols

Communication between devices requires they agree on the format in which the data is to be transmitted, sent and received. The communications protocols are a set of rules that define the data format.

DHCP

DHCP, short for Dynamic Host Configuration Protocol, is a protocol for assigning dynamic IP Addresses to devices on a network. Dynamic Addressing means that a device can have a different IP Address each time it connects to the network.

Domain Name

A name that identifies one or more IP Addresses. For example, the domain name microsoft.com represents about a dozen IP Addresses. Domain names are used in URLs to identify particular Web pages. For example, in the URL <http://www.pcwebopedia.com/index.html>, the domain name is pcwebopedia.com.

DNS

Short for Domain Name Server, translates domain names into IP Addresses. To help us recognize and remember domain names they are alphabetic in form, however, the Internet actually runs on numbered IP Addresses. DNS servers translate domain names into their respective IP Addresses.

DSSS

Also known as Direct Sequence Spread Spectrum, it is a radio transmission method that continuously changes frequencies.

Ethernet

One of the most common Local Area Network (LAN) standards. Ethernet uses a bus topology which supports a data transfer rate of 10 or 100 Mbps.

ESS

ESS is the acronym of Extend Service Set that consists of several BSS.

Firewall

A security system used to enforce an access control policy between an organisation's networks and the Internet.

IEEE

Short for Institute of Electrical and Electronics Engineers, an organization best known for developing standards for the computer and electronics industry.

Internet

A global network connecting millions of computers for the exchange of data, news and opinions.

Intranet

A network based on TCP/IP Protocol belonging to an organization, and accessible only by that organization's members, employees, or others with authorization.

Infrastructure Network

Unlike an ad-hoc network (where users on a wireless LAN send data to each other directly), users on an infrastructure network send data through a dedicated access point. Additionally, the access point enables users on a wireless LAN to access an existing wired network to take advantage of sharing the wired networks resources, such as files, printers, and Internet access.

IP Address

An identifier for a computer or device on a TCP/IP network. Networks using the TCP/IP Protocol route messages based on the IP Address of the destination. The format of an IP address is a 32-bit numeric address written as four numbers separated by periods. Each number can be from zero to 255.

IPSec

Internet Protocol Security is a security standard for network transmission, which is often used for VPN connections. It provides authentication and packet encryption over the Internet.

ISP

Short for Internet Service Provider, a company that provides access to the Internet for a fee.

Local Area Network (LAN)

A computer network that spans a relatively small area. Most LANs are confined to a single building or group of buildings. However, one LAN can be connected to other LANs over any distance. A system of LANs connected in this way is called a wide area network (WAN)

MAC Address

Short for Media Access Control Address, a hardware address that uniquely identifies each node of a network.

NAT

Short for Network Address Translation, a routing protocol that allows global IP Addresses to be translated into multiple private IP Addresses for use on internal LAN networks. The explosion in the use of the Internet has created a critical problem for the Internet Assigned Numbers Authority (IANA) which is in charge of assigning IP Addresses to Internet users, ISPs etc. NAT is a technology that has been introduced to help maximize the utilization of assigned IANA and global IP Addresses.

Network Protocol

Network protocols encapsulate and forward data packets from one interface to another.

PAP/CHAP

Short for Password Authentication Protocol and Challenge Handshake Authentication Protocol. Most ISPs use either one for user identification. If your ISP doesn't support these two protocols, contact them for an authentication script.

PPP

Short for Point-to-Point Protocol, a communications protocol for transmitting information over standard telephone lines between devices from different manufacturers.

PPPoE

Short for PPP over Ethernet, relying on two widely accepted standards, Ethernet and the Point-to-Point Protocol. PPPoE is a communications protocol for transmitting information over the Ethernet between devices from different manufacturers.

PPTP

The acronym of Point to Point Tunnelling Protocol, PPTP encapsulates the packet for transmission over the Internet. It creates a private "tunnel" through the large public network to have similar security of private network without actually leasing a private line. PPTP is normally used for VPN connections.

Protocol

An agreed format for transmitting, sending and receiving data between two devices.

Roaming

The ability for a wireless device moves from one access point's range to another without losing the connection.

Router

An Internet device that routes requests for information to other routers until the information's location is found and the data can be transmitted back to the origin of the request.

TCP/IP

Short for Transmission Control Protocol and Internet Protocol, the suite of communications protocols that enable hosts on the Internet to connect and exchange streams of data.

VPN

The acronym for Virtual Private Network. Via access control and encryption, VPN brings the security to the data transmission through the Internet as it is transmitted through a private network. It not only takes advantage of economies of scale but also secures a high level of security while the packet is sent over the large public network.

Wide Area Network (WAN)

A system of LANs being connected by telephone lines and radio waves. Although some WANs may be privately owned, they are usually considered a means of public access.

WEP

The acronym for Wired Equivalent Privacy. It is an encryption mechanism used to protect your wireless data communications. WEP uses a combination of 64-bit/128-bit keys to encrypt data that is transmitted between all points in a wireless network to ensure data security. It is described in the IEEE 802.11 standard.

Appendix D: Registering your NetComm Product

To ensure that the conditions of your warranty are complied with, please go to the NetComm web site for quick and easy registration of your product at

www.netcomm.com.au

Alternatively, you can print out a copy of the Warranty Registration Form and mail it to NetComm Limited, PO Box 1200, Lane Cove NSW 2066.

Note: *The Warranty Registration Form can be found at “D:\Manuals\Warranty Registration Form.pdf” where D:\ is the letter of your CD-ROM drive.*

Contact Information

If you have any technical difficulties with your produce, please do not hesitate to contact NetComm’s Customer Support Department.

Email: support@netcomm.com.au

Fax: (02) 9424-2010

Web: www.netcomm.com.au

Product Warranty

The warranty is granted on the following conditions:

1. This warranty extends to the original purchaser (you) and is not transferable;
2. This warranty shall not apply to software programs, batteries, power supplies, cables or other accessories supplied in or with the product;
3. The customer complies with all of the terms of any relevant agreement with NetComm and any other reasonable requirements of NetComm including producing such evidence of purchase as NetComm may require;
4. The cost of transporting product to and from NetComm's nominated premises is your responsibility; and,
5. NetComm does not have any liability or responsibility under this warranty where any cost, loss, injury or damage of any kind, whether direct, indirect, consequential, incidental or otherwise arises out of events beyond NetComm's reasonable control. This includes but is not limited to: acts of God, war, riot, embargoes, acts of civil or military authorities, fire, floods, electricity outages, lightning, power surges, or shortages of materials or labour.
6. The customer is responsible for the security of their computer and network at all times. Security features may be disabled within the factory default settings. NetComm recommends that you enable these features to enhance your security.

The warranty is automatically voided if:

1. You, or someone else, use the product, or attempts to use it, other than as specified by NetComm;
2. The fault or defect in your product is the result of a voltage surge subjected to the product either by the way of power supply or communication line, whether caused by thunderstorm activity or any other cause(s);
3. The fault is the result of accidental damage or damage in transit, including but not limited to liquid spillage;
4. Your product has been used for any purposes other than that for which it is sold, or in any way other than in strict accordance with the user manual supplied;
5. Your product has been repaired or modified or attempted to be repaired or modified, other than by a qualified person at a service centre authorised by NetComm; and,
6. The serial number has been defaced or altered in any way or if the serial number plate has been removed.

Limitations of Warranty

The Trade Practices Act 1974 and corresponding State and Territory Fair Trading Acts or legalisation of another Government ("the relevant acts") in certain circumstances imply mandatory conditions and warranties which cannot be excluded. This warranty is in addition to and not in replacement for such conditions and warranties.

To the extent permitted by the Relevant Acts, in relation to your product and any other materials provided with the product ("the Goods") the liability of NetComm under the Relevant Acts is limited at the option of NetComm to:

- Replacement of the Goods; or
- Repair of the Goods; or
- Payment of the cost of replacing the Goods; or
- Payment of the cost of having the Goods repaired.

All NetComm ACN 002 490 486 products have a standard 12 months warranty from date of purchase. However some products have an extended warranty option (refer to packaging). To be eligible for the extended warranty you must supply the requested warranty information to NetComm within 30 days of the original purchase by registering on-line via the NetComm web site at www.netcomm.com.au.

NetComm reserves the right to request proof of purchase upon any warranty claim.

NB3300 ADSL Modem Router

BUILD AND PROTECT A HIGH-SPEED SWITCHED NETWORK

All you ever wanted in high-speed networking and Internet access. With this NetComm NB300, you can quickly and easily create a high-speed Local Area Network (LAN), connect it to a broadband ADSL service available from many Australian ISPs and enjoy the ultimate in speed, security and control. If you already have a LAN, you can connect it to ADSL, plus add four extra high-speed switched ports and a DHCP server to your network.

WHY IS DSL SO POPULAR?

DSL (Digital Subscriber Line) is a technology used to carry high-speed data transmissions over the standard twisted-pair copper wires that connect to the telephone network. DSL technology allows you to use the phone line for ordinary voice or fax traffic at the same time as it is used for this high-speed data transmission. DSL has become popular because it provides high-speed Internet access without the need for new cabling or even an extra telephone line.

WHAT IS ADSL?

Asymmetric Digital Subscriber Line (ADSL) is an asymmetrical data transmission technology with higher traffic rates downstream and lower traffic rates upstream. ADSL is suitable for Internet users because information is usually downloaded more often than uploaded, such as when browsing the web or downloading files.

INTEGRATED 10/100 4-PORT SWITCH

You can build or expand a wired network by connecting other LAN devices via the NB300's built-in 10/100 4-port Ethernet switch.

ROUTER TO SHARE YOUR ADSL INTERNET

You can use just one ADSL ISP account for all your Internet requirements, yet still have everyone on your network have their own e-mail addresses.

WORKS WITH ALL ADSL SERVICE PROVIDERS

The NB300 has been specially engineered to work with all Australian ADSL ISPs.

BUILT-IN DHCP SERVER

To make operation even simpler, the NetComm NB300 also acts as a DHCP server. DHCP assigns IP addresses automatically as users log on. It is popular because it can save a lot of IP configuration.

SUPPORTS VPN, IPSEC AND PPP PASS-THROUGH

A Virtual Private Network (VPN) allows workers to securely access your LAN from remote locations such as their homes, via the Internet. The NetComm NB300 is VPN-ready and supports a single session IPsec or PPP pass-through.

REMOTE ADMINISTRATION VIA THE INTERNET

The NetComm NB300 can be set up to allow remote administration from anywhere on the Internet or the local network.

QUICK AND EASY TO INSTALL

Installing the NetComm NB300 couldn't be easier with a web browser set-up and simple one-page set-up screen. You can connect any system that runs the Internet protocol TCP/IP including PCs, Macs and Linux.

REMOTE ADMINISTRATION AND REMOTE UPGRADES

The NetComm NB300 can be set up to allow remote administration from anywhere on the Internet.

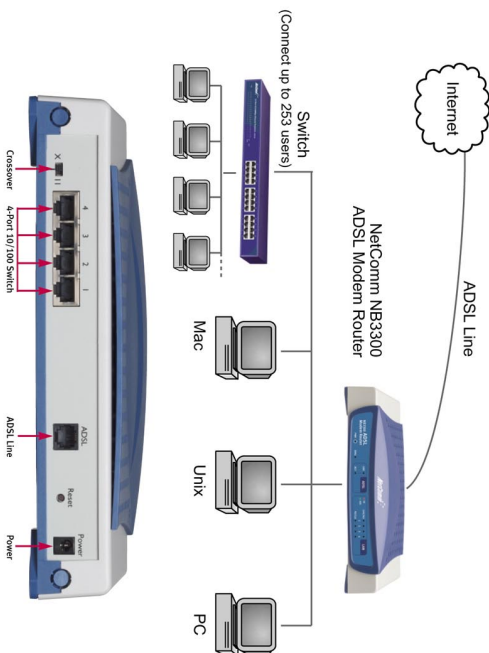

NetComm is Australia's dynamic data communications and networking solutions provider.

For more information on this and other NetComm products, please visit www.netcomm.com.au

PHONE: (02) 9424 2070 • FAX: (02) 9424 2010 • EMAIL: sales@netcomm.com.au

www.netcomm.com.au

Trademarks and registered trademarks are the property of NetComm, Ltd or their respective owners. Specifications are subject to change without notice. Images shown may vary slightly from the enclosed product.

Product Code: NB3300

3 YEAR WARRANTY*

1 year warranty out of the box.
Extra 2 years FREE with online
registration at www.netcomm.com.au
*Conditional upon registration online.